

CS 6940EN

TWO-WAY COLUMN SPEAKER

DESCRIPTION

CS 6940EN is a compact and elegant two-way column speaker providing highly intelligible voice reproduction, and suitable for installation into places of worship, stations, subways and many other environments. The terminal connection blocks, for input and output flameproof cables, are made of ceramic material. A thermal fuse protects the integrity of the line in case of heat affecting the speaker. Ground screw available (if needed). Thanks to its IP66 protection grade, it can be installed both indoor and outdoor.

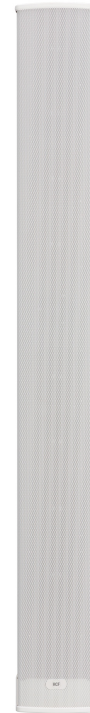

FEATURES

- 8 x 3" fullrange transducers with 0.75" dome tweeter.
- Power selectable (100 V): 40 W – 20 W – 10 W – 5 W – 2.5 W.
- 95 dB sensitivity.
- Colour white RAL 9003.
- Aluminium body, grille and bracket.
- In/out ceramic terminal block.
- Thermal fuse protection.
- Protection grade IP66.

TECHNICAL SPECIFICATIONS

Acoustical specifications	Frequency Response (-10dB)	140 Hz ÷ 20000 Hz
	Max SPL @ 1m	109 dB
	Max SPL @ 4m	97 dB
	Horizontal coverage angle	194°
	Vertical coverage angle	30°
	System Sensitivity	95 dB
	System Sensitivity 1W @ 4m	83 dB
Power section	Amplification	Full Range
	Power Handling	40 W
	Peak Power Handling	160 W PEAK
	Protections	Thermal fuse
	Recommended Amplifiers	DXT 3000, DXT 4000, DXT 7000
Transducers	Dome Tweeter	1 x 0.75"
	Fullrange	8 x 3.0"
Input/Output section	Input connectors	Ceramic screw terminals
	Output connectors	Ceramic screw terminals
	Constant Voltage Transformer	70/100 V
	Power selection 1	40 W - 250 ohm
	Power selection 2	20 W - 500 ohm
	Power selection 3	10 W - 1000 ohm
	Power selection 4	5 W - 2000 ohm
Power selection 5	2.5 W - 4000 ohm	
Standard compliance	IP protection grade	IP 66
	Safety agency	CE compliant
	EN54-24 certified	Yes
	CPR number	1488-CPR-0490/W
Physical specifications	Color	White - RAL 9003
Size	Height	995 mm / 39.17 inches
	Width	114 mm / 4.49 inches
	Depth	96 mm / 3.78 inches
	Weight	7 kg / 15.43 lbs
Shipping information	Package Height	200 mm / 7.87 inches
	Package Width	1090 mm / 42.91 inches
	Package Depth	170 mm / 6.69 inches
	Package Weight	8.4 kg / 18.52 lbs



PART NUMBER

- **13100005**
CS 6940EN

EAN 8024530013684

DRAWINGS

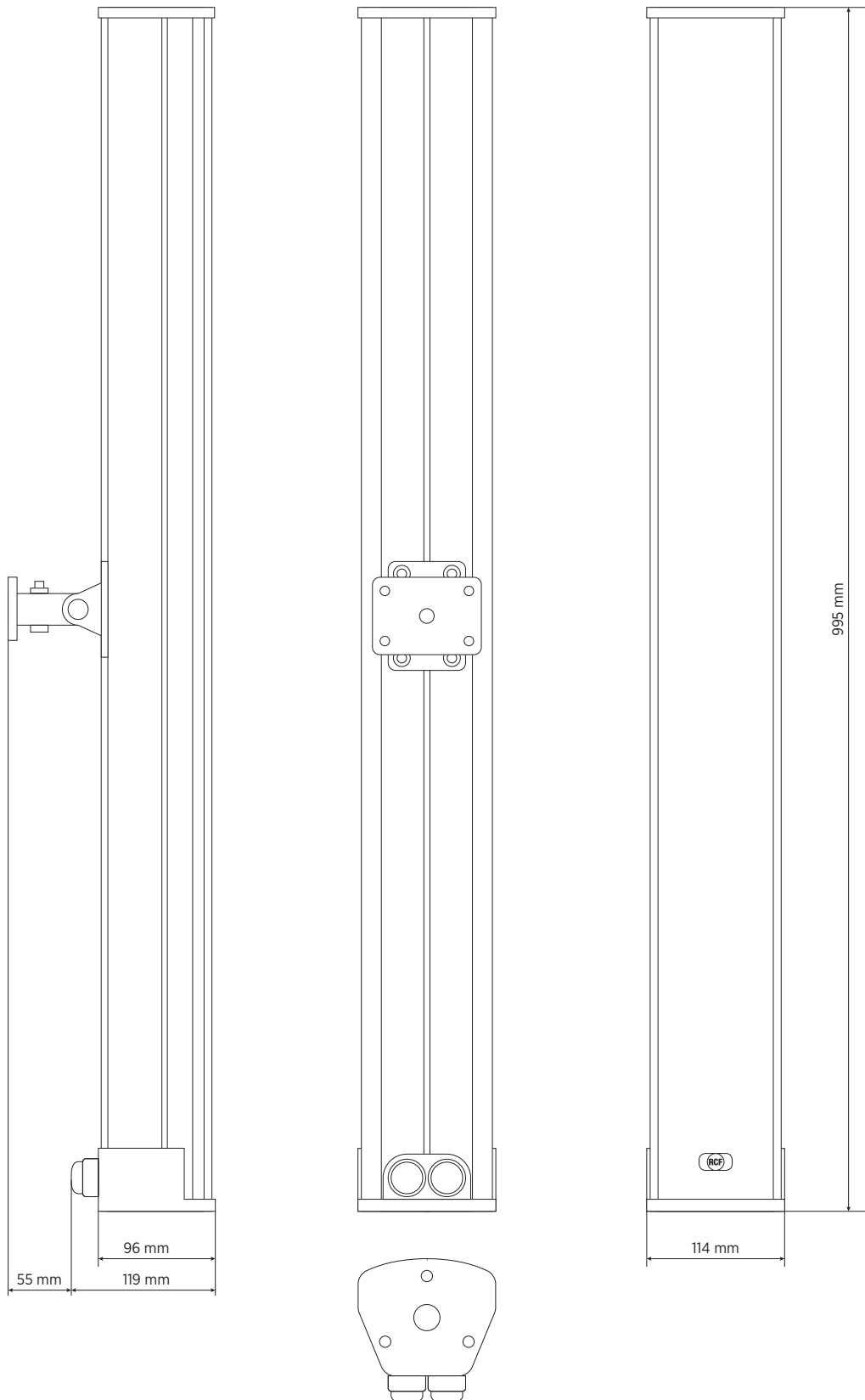

SCHEMATICS

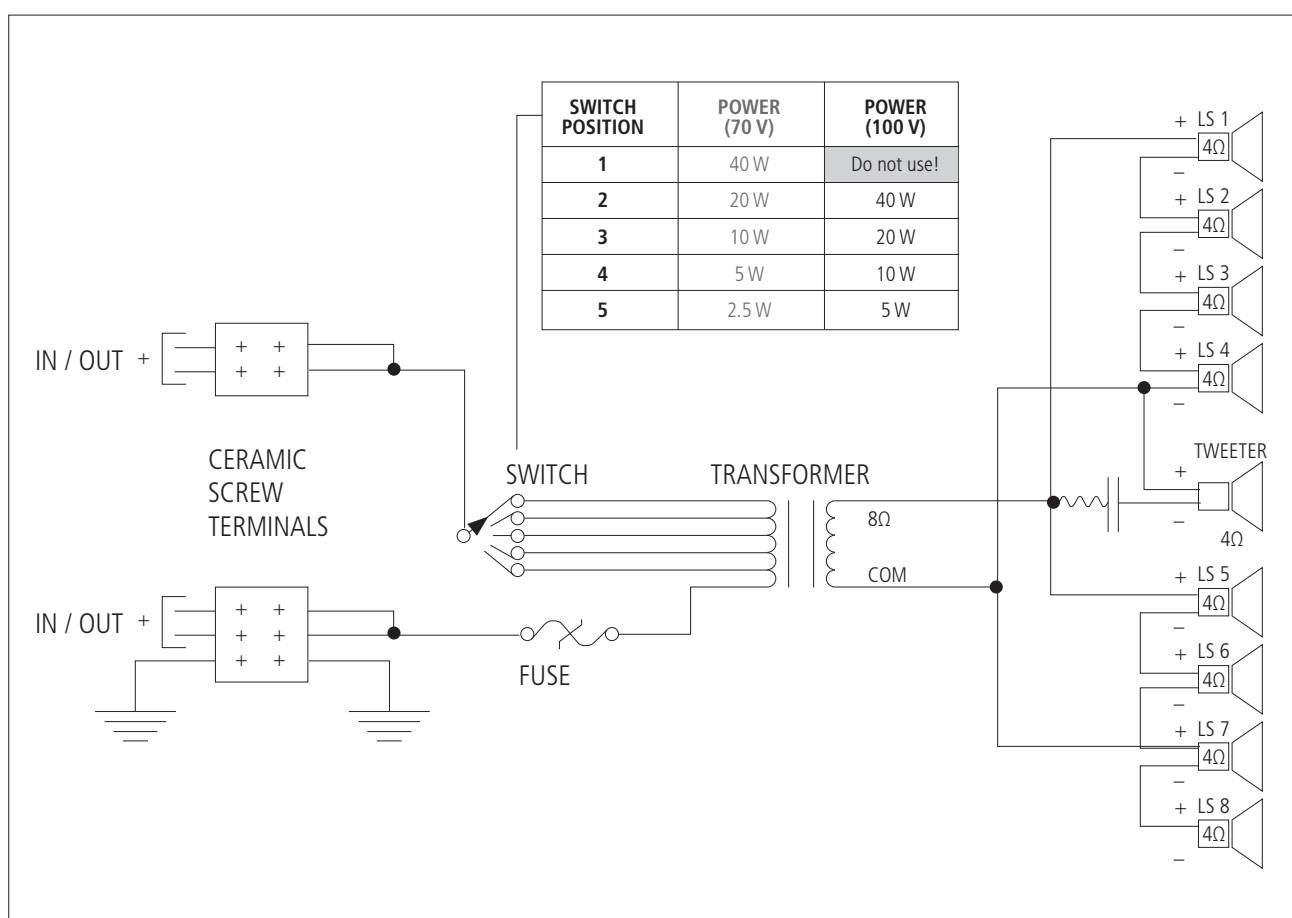

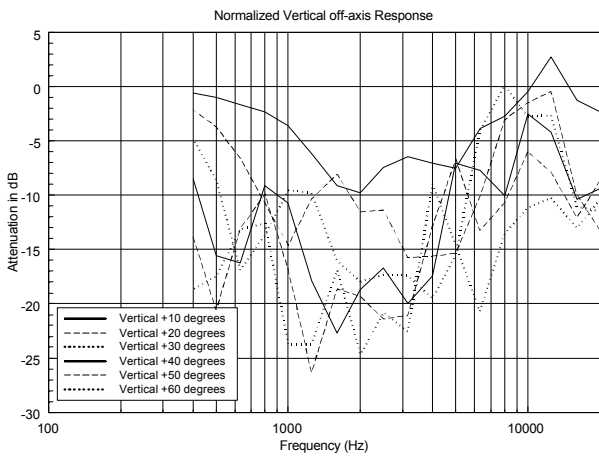
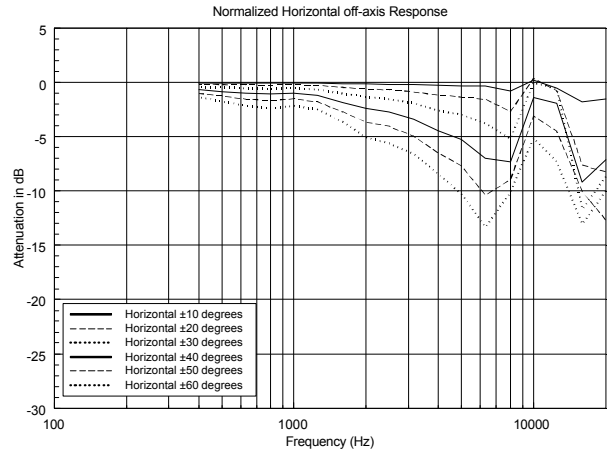
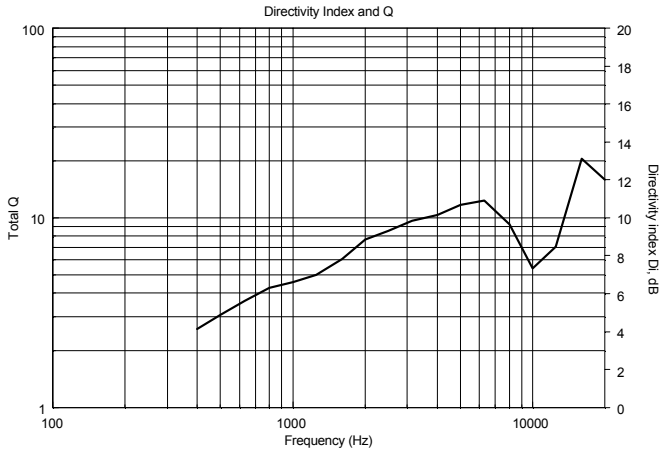
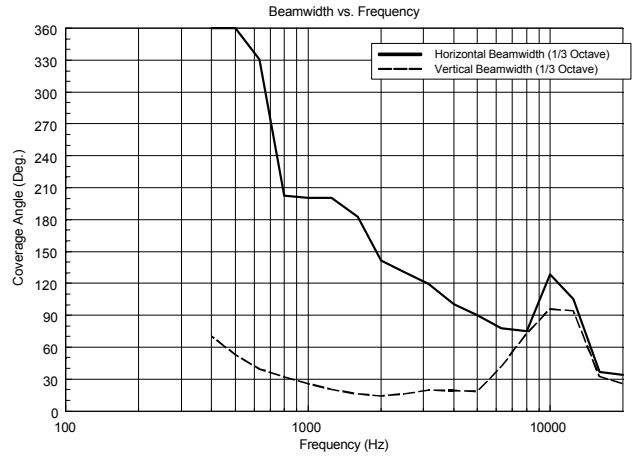
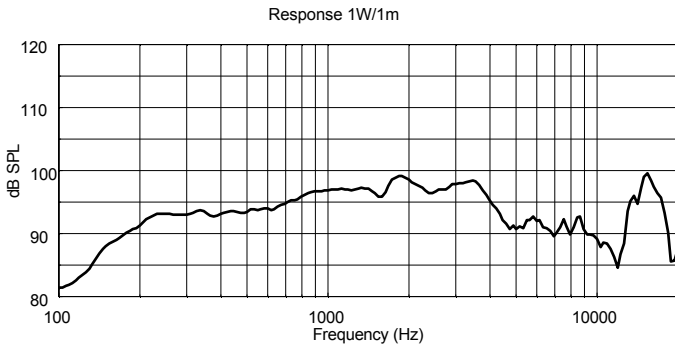

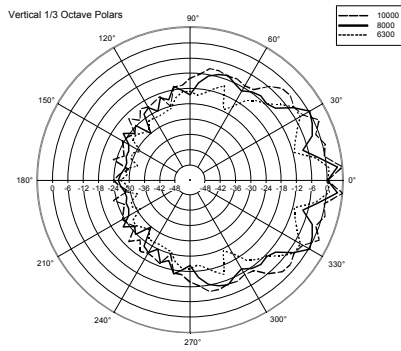
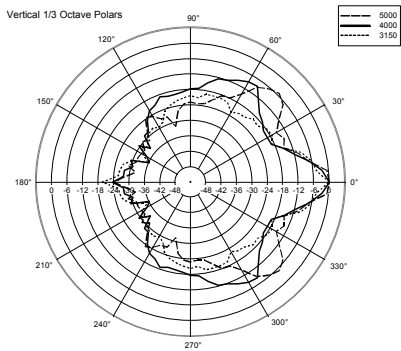
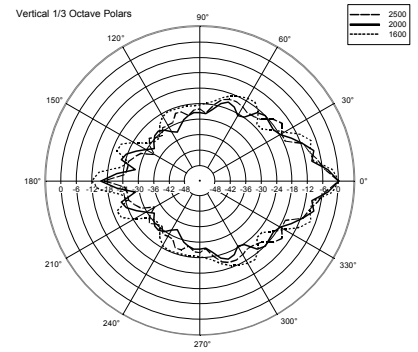
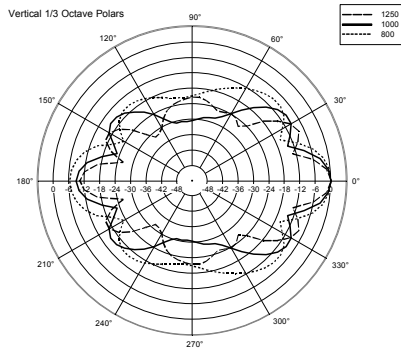
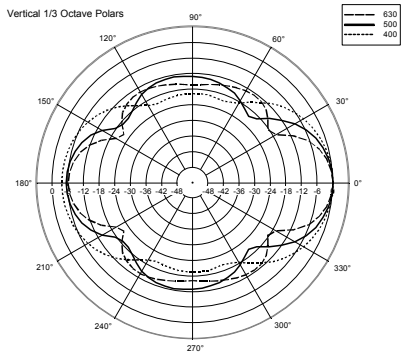
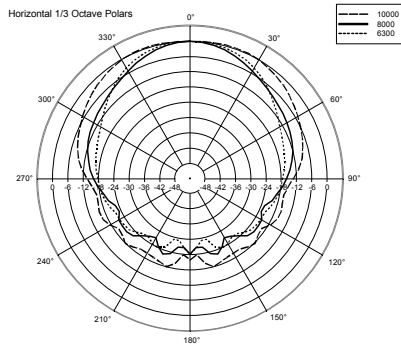
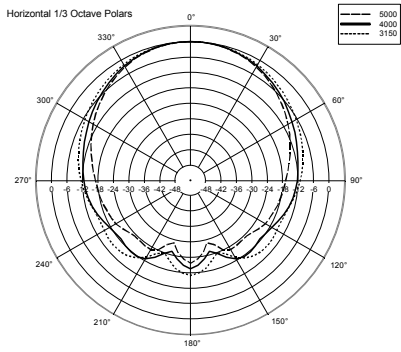
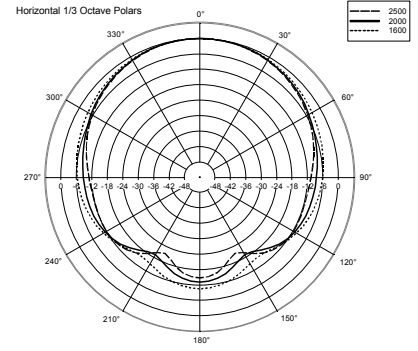
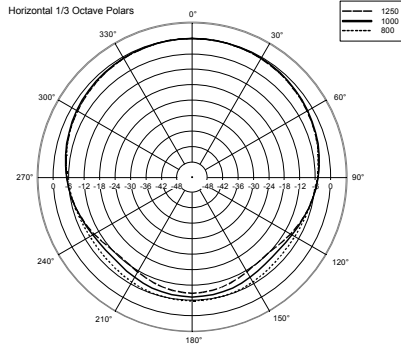
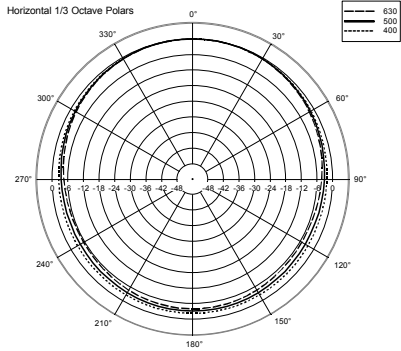



ACCESSORIES

A&E SPECIFICATIONS

The product shall be a compact and elegant two-way column speaker for broadcasting background music into commercial spaces, but also alarm messages, thanks to the highly intelligible voice reproduction and the EN 54-24 certification.

It shall be suitable for places of worship, stations, subways or any other environment.

It shall have IP66 protection grade for both indoor and outdoor installations.

It shall feature an aluminium body and front grille.

The terminal connection blocks, for input and output flameproof cables, shall be made of ceramic material. A thermal fuse shall protect the line integrity in case of heat affecting the speaker.

NOTES

NO CAUTION is NECESSARY in case of ALERTED PERSON for AUDIO voltages up to 120V, when warning symbols are present near the connection terminals. In the case of AUDIO voltages up to 71V, it is not even necessary to put warning symbols.

No need of linking to earth metal parts of speakers equipped with transformers and connected to 70.7 V / 100 V outputs of power amplifiers that do not have any reference to earth (ref. EN 62368-1 item 4.3.2.2), unless specific local requirements.