

FL-B HDL 28

FLY BAR

DESCRIPTION

Flybar for HDL 28-A or HDL 36-AS + 1x Pickup Tab with Shackle + Stacking Bar + Mounting Bracket for inclinometer. Pins included.

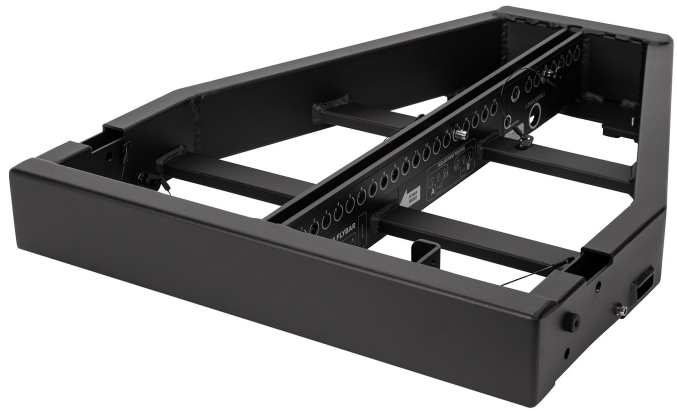

FEATURES

- To suspend up to 20 modules
- Strong steel construction

TECHNICAL SPECIFICATIONS

General specifications	Max number of speaker HDL 28-A	20
	Max nr. of speaker HDL 36 and HDL 28	6+12
	Max number of speaker HDL 36-A	12
Standard compliance	CE marking:	Yes
Physical specifications	Cabinet/Case Material:	Steel
Size	Weight:	19.8 kg / 43.65 lbs
Shipping informations	Package Height:	125 mm / 4.92 inches
	Package Width:	645 mm / 25.39 inches
	Package Depth:	495 mm / 19.49 inches
	Package Weight:	27.6 kg / 60.85 lbs

PART NUMBER

- **13360411**

FL-B HDL 28

EAN 8024530016258

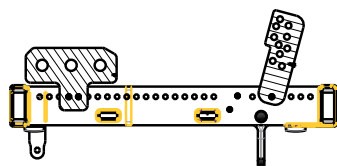

A-A

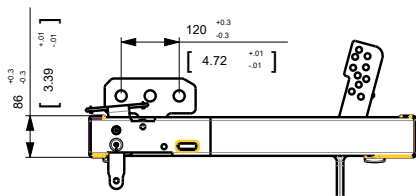

1:10

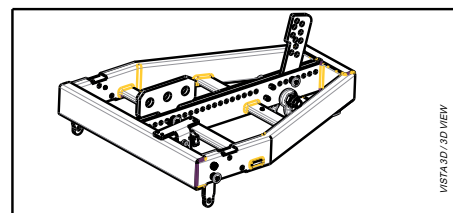
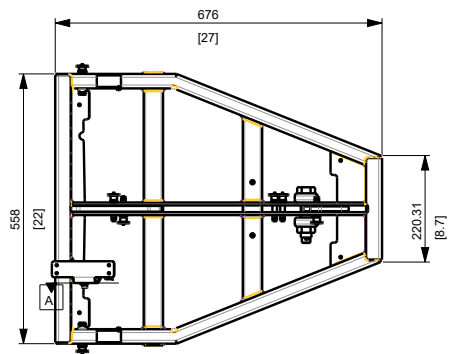
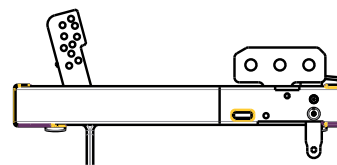
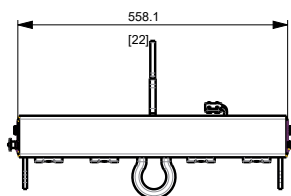

1/31/2013 10:00 AM

	FLY BAR FL-B HDL 28	REV. A
--	---------------------	-----------