

DP 5EN

UNIDIRECTIONAL SOUND PROJECTOR

DESCRIPTION

DP 5EN is a weatherproof sound projector suitable for all those installations where high intelligibility for alarm messages broadcasting and great sound reproduction quality are required. Thanks to its IP65 protection grade, it can be installed both indoor and outdoor. Moreover, a modern and endearing design makes it the perfect product for environments where projectors are intended also as architectural elements and contribute to improve global aesthetics.



FEATURES

- 5" fullrange transducer.
- Power selectable (100 V): 20 W – 10 W – 5 W – 2.5 W.
- 88 dB sensitivity.
- Colour white RAL 9016.
- Flameproof ABS body, steel grille.
- In/out ceramic terminal block.
- Thermal fuse protection.
- Protection grade IP65.

TECHNICAL SPECIFICATIONS

Acoustical specifications	Frequency Response (-10dB):	80 Hz ÷ 20000 Hz
	Max SPL @ 1m:	101 dB
	Max SPL @ 4m:	89 dB
	Coverage angle:	210°
	System Sensitivity:	88 dB
	System Sensitivity 1W @ 4m:	76 dB
Power section	Power Handling:	20 W
	Peak Power Handling:	80 W PEAK
	Recommended Amplifier:	40 W
	Protections:	Thermal fuse
Transducers	Fullrange:	5.0"
Input/Output section	Input connectors:	Ceramic screw terminals
	Output connectors:	Ceramic screw terminals
	Constant Voltage Transformer:	100 V
	Power selection 1:	20 W - 500 ohm
	Power selection 2:	10 W - 1000 ohm
	Power selection 3:	5 W - 2000 ohm
	Power selection 4:	2.5 W - 4000 ohm
Standard compliance	IP protection grade:	IP 65
	EN54-24 certified:	Yes
	CE marking:	Yes
	CPR number:	0068-CPR-058/2014
Physical specifications	Cabinet/Case Material:	ABS
	Hardware:	Wall mount metal plate
	Grille:	Steel
	Color:	White - RAL 9016
Size	Height:	183 mm / 7.2 inches
	Width:	176 mm / 6.93 inches
	Depth:	261 mm / 10.28 inches
	Weight:	2.61 kg / 5.75 lbs
Shipping informations	Package Height:	230 mm / 9.06 inches
	Package Width:	400 mm / 15.75 inches
	Package Depth:	380 mm / 14.96 inches
	Package Weight:	3.54 kg / 7.8 lbs



PART NUMBER

- **13133076**

DP 5EN

White - RAL 9016

EAN 8024530011123

DRAWINGS

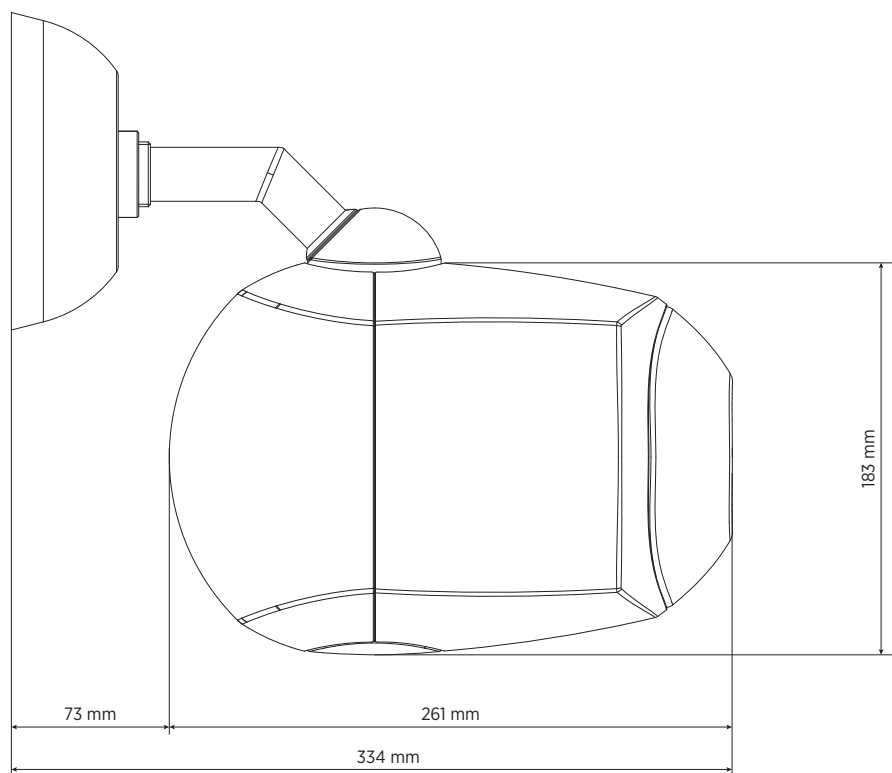
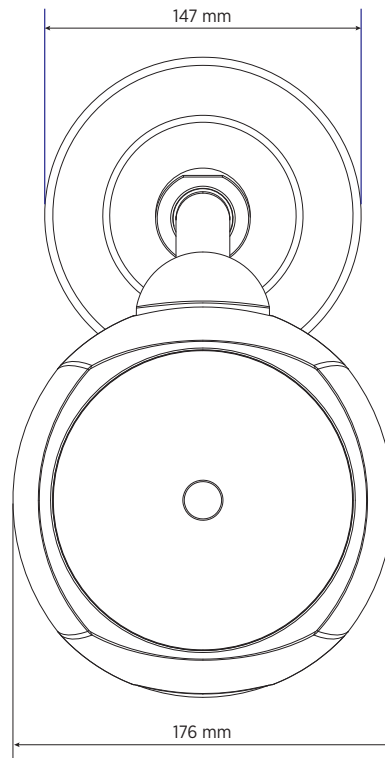

SCHEMATICS



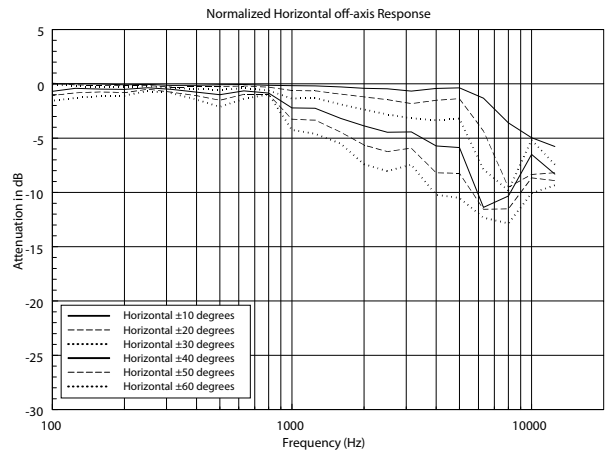
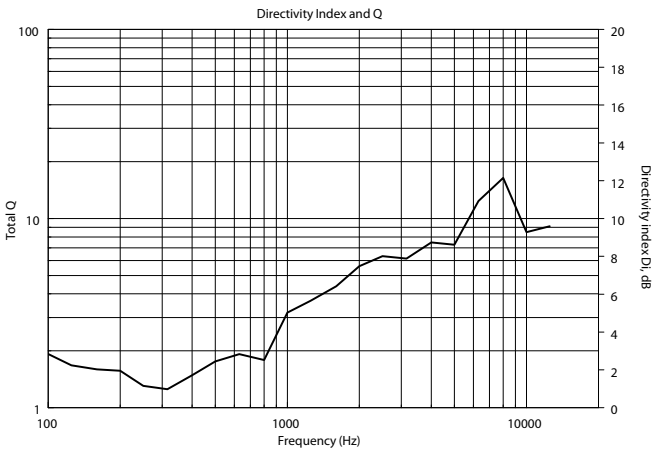
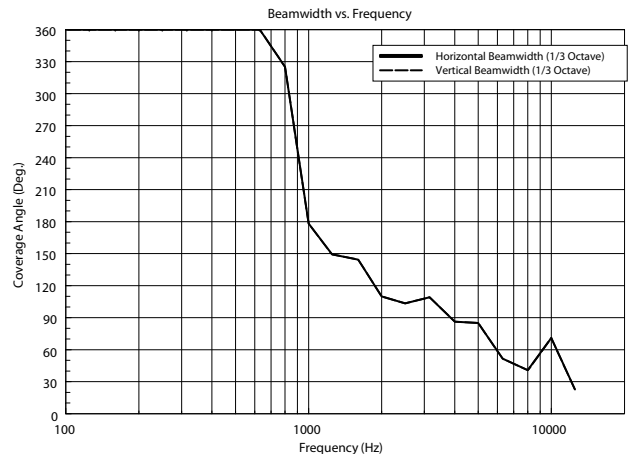
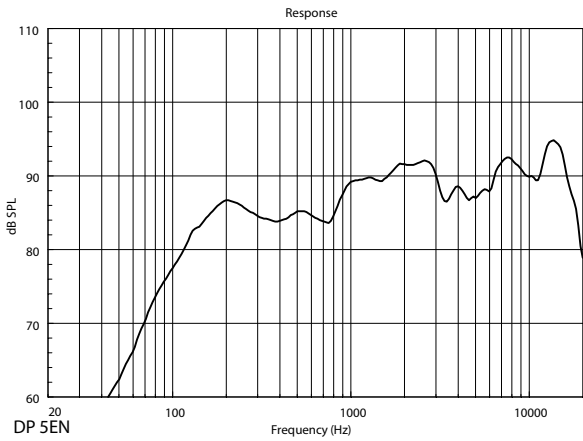

HORIZONTAL 1/3 POLAR PLOT

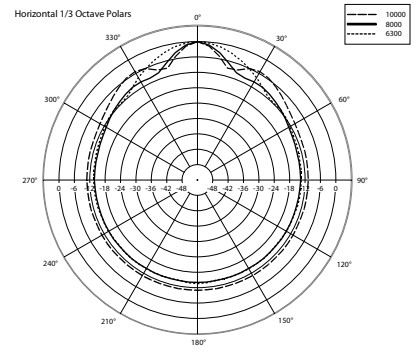
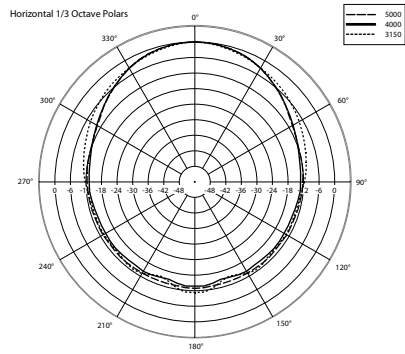
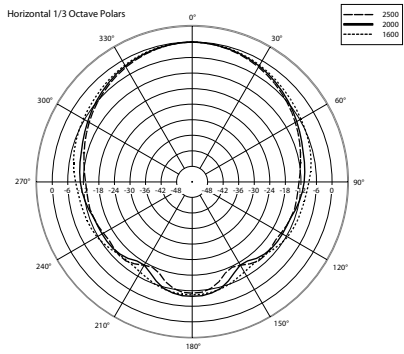
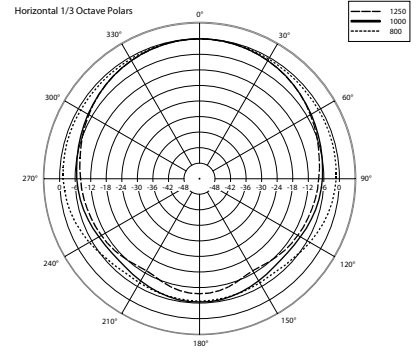
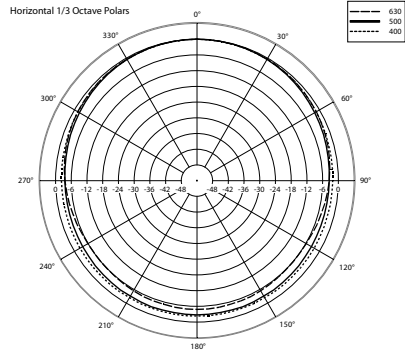
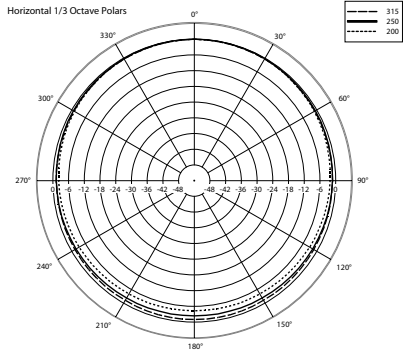



ACCESSORIES



A&E SPECIFICATIONS

The product shall be a weatherproof sound projector suitable for broadcasting background music into commercial spaces, but also alarm messages, thanks to the highly intelligible voice reproduction and the EN 54-24 certification.

It shall have IP65 protection grade for both indoor and outdoor installations.

It shall have a modern and endearing design for environments where projectors are intended also as architectural elements and contribute to improve global aesthetics.

The terminal connection blocks, for input and output flameproof cables, shall be made of ceramic material. A thermal fuse shall protect the line integrity in case of heat affecting the speaker.

NOTES

NO CAUTION is NECESSARY in case of ALERTED PERSON for AUDIO voltages up to 120V, when warning symbols are present near the connection terminals. In the case of AUDIO voltages up to 71V, it is not even necessary to put warning symbols.

No need of linking to earth metal parts of speakers equipped with transformers and connected to 70.7 V / 100 V outputs of power amplifiers that do not have any reference to earth (ref. EN 62368-1 item 4.3.2.2), unless specific local requirements.
