

P 2110T

WEATHERPROOF COAXIAL TWO-WAY SPEAKER

DESCRIPTION

The P 2110T is a weatherproof full-range, wide-dispersion, coaxial two-way loudspeaker system for a variety of professional indoor or outdoor applications. The speaker can be installed individually or coupled in array configurations. The low-frequency transducer is a 10" woofer with a 2.5" voice coil. The high-frequency section combines a 1" RCF Precision compression driver with a 1.5" diaphragm assembly centrally-mounted in the throat of the LF driver, and loaded on a constant directivity CMD horn for smooth, wide dispersion. The P 2110T features a selectable line transformer for 70 - 100 volt applications, built-in LICC crossover, and Active Mosfet Compression Driver Protection (AMCDP). The single-piece roto-molded cabinet is fully UV protected and meets IP-55 standard requirements. Included are M10 brass inserts (12 x) and one durable corrosion-resistant 316P stainless steel U-Bracket with spacers (2x) for 90° mounting. The aluminum grille cover is powder coated with water-repellent backing material and a rotatable logo plate.



FEATURES

- 200 W RMS power handling
- 124 dB max SPL
- 95 Hz ÷ 20000 Hz frequency range
- 10" woofer, 2.5" v.c.
- 1.5" v.c. compression driver
- 90° x 40° constant directivity
- Weatherproof IP55 cabinet with UV protection
- Aluminum grille
- AISI 316L stainless steel bracket
- Built in 100V line transformer

TECHNICAL SPECIFICATIONS

Acoustical specifications	Frequency Response (-10dB)	95 Hz ÷ 20000 Hz
	Max SPL @ 1m	124 dB
	Horizontal coverage angle	90°
	Vertical coverage angle	40°
	Directivity index Q	11
	System Sensitivity	95 dB
Power section	Amplification	Full Range
	Nominal Impedance	16 ohm
	Power Handling	200 W
	Peak Power Handling	800 W PEAK
	Protections	Dynamic active mosfet
	Crossover Frequencies	2000 Hz
Transducers	Compression Driver	1.0", 1.5" v.c
	Woofers	Coaxial 10", 2.5" v.c
Input/Output section	Input connectors	Neoprene Cable
	Constant Voltage Transformer	100 V
	Power selection 1	60 W - 167 ohm
	Power selection 2	30 W - 333 ohm
	Power selection 3	15 W - 667 ohm
Standard compliance	IP protection grade	IP 55
	Safety agency	CE compliant
Physical specifications	Hardware	12 x M8 inserts + U-brackets and pair of spacers
	Color	Grey
Size	Height	350 mm / 13.78 inches
	Width	350 mm / 13.78 inches
	Depth	320 mm / 12.6 inches
	Weight	13.4 kg / 29.54 lbs
Shipping information	Package Height	400 mm / 15.75 inches
	Package Width	370 mm / 14.57 inches
	Package Depth	370 mm / 14.57 inches
	Package Weight	16.3 kg / 35.94 lbs

PART NUMBER

- **13000125**

P 2110T

EAN 8024530008246

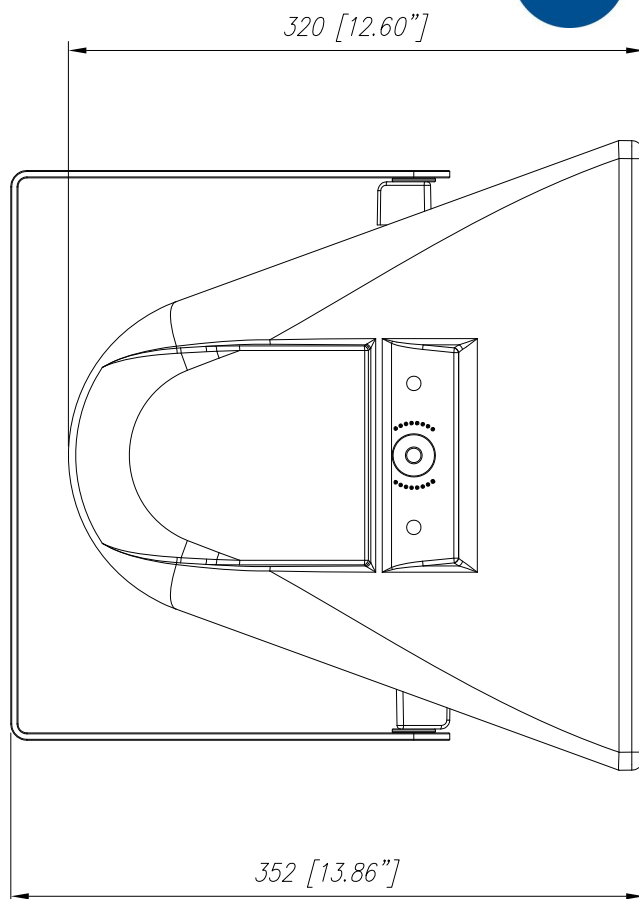
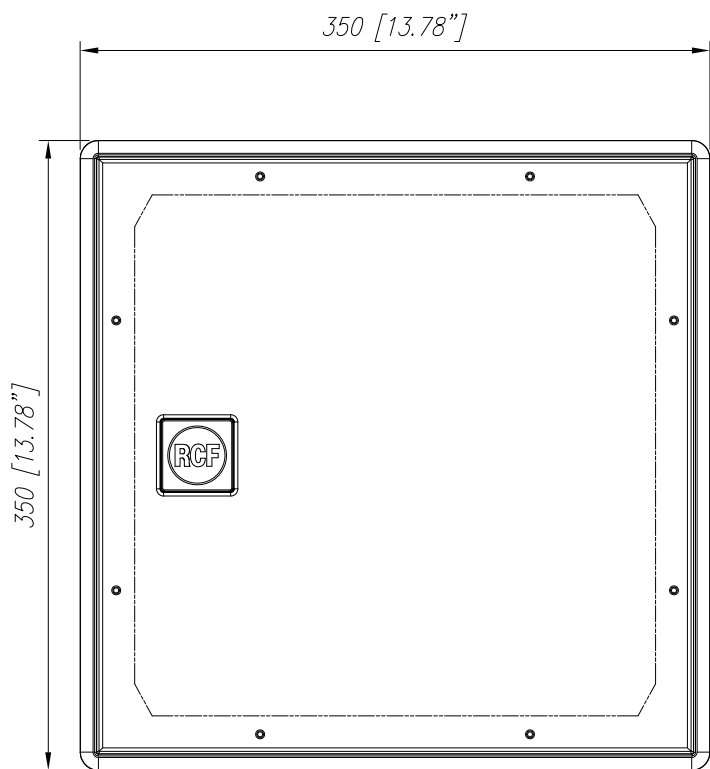

P2110

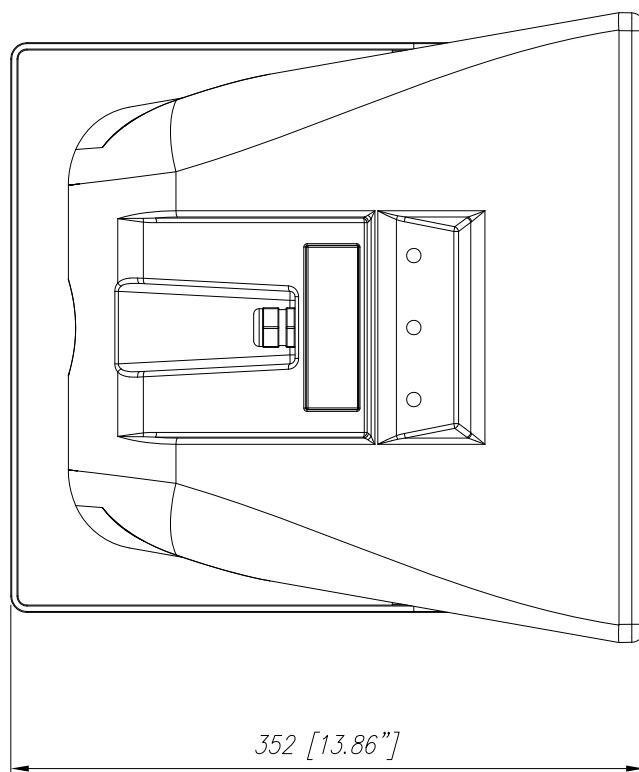

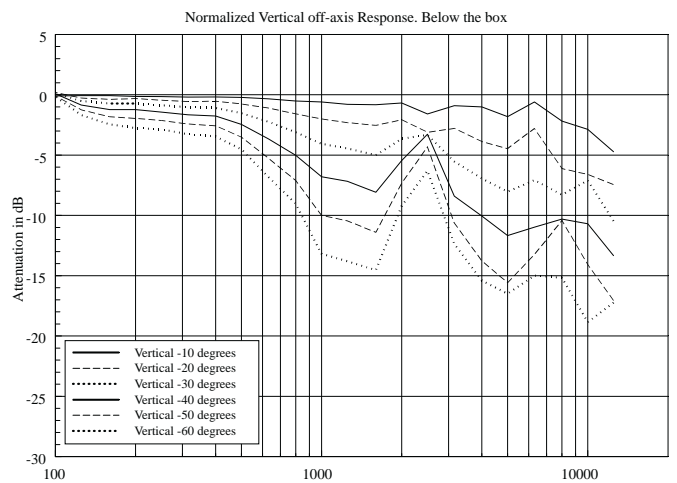
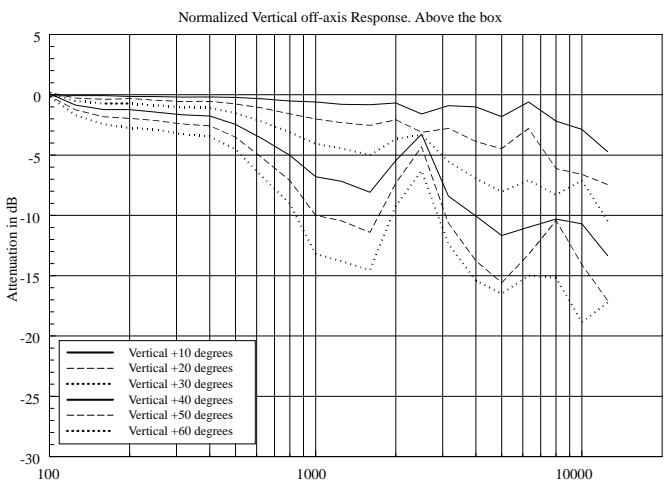
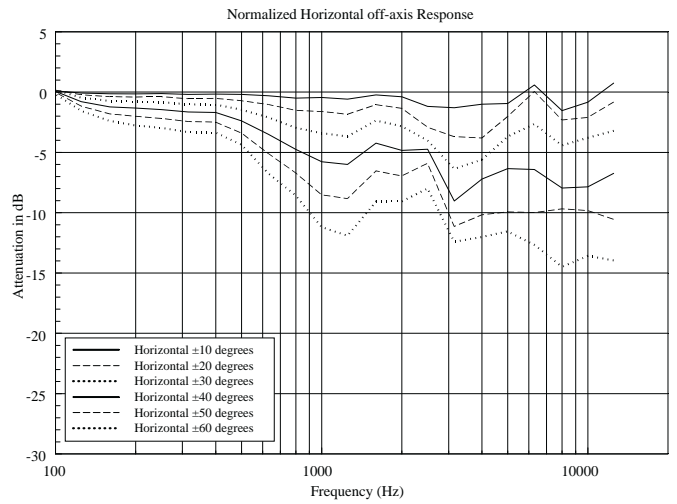
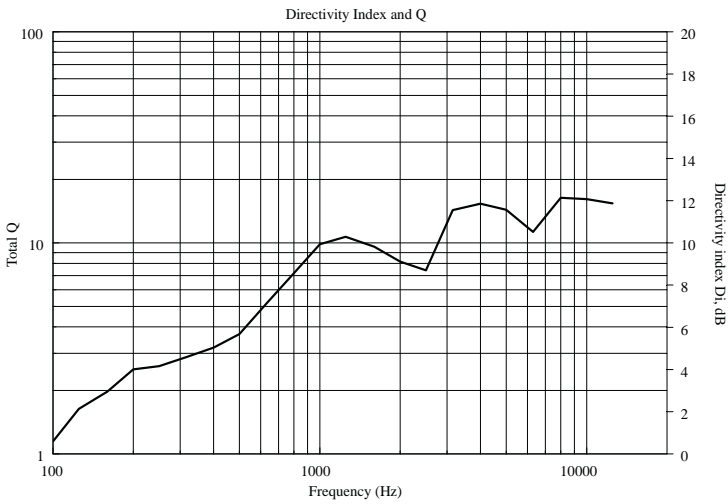
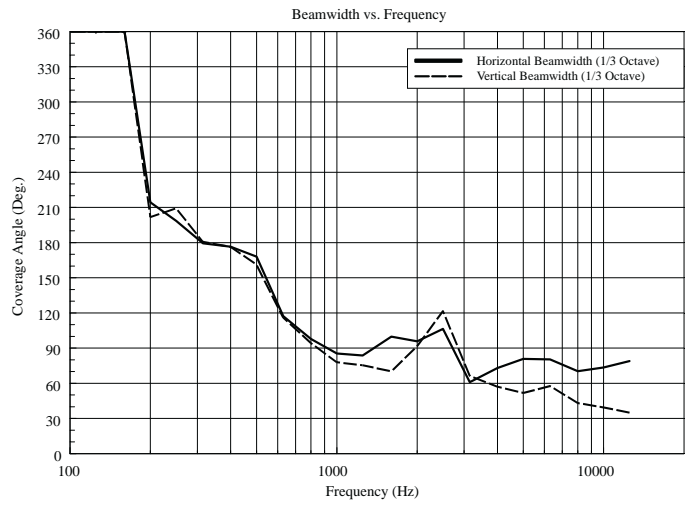
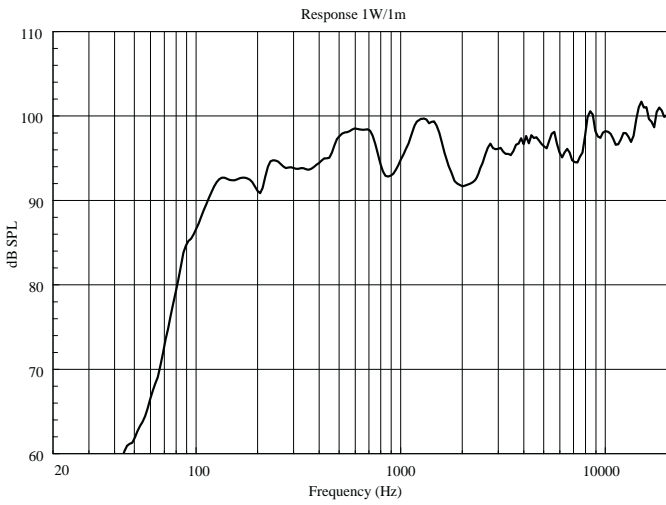

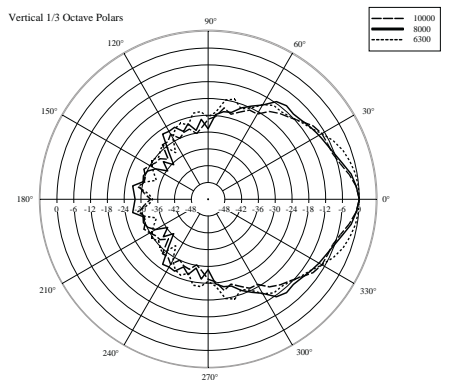
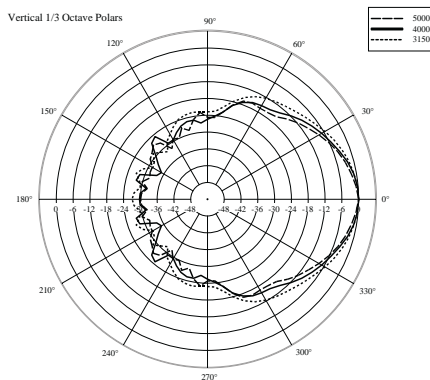
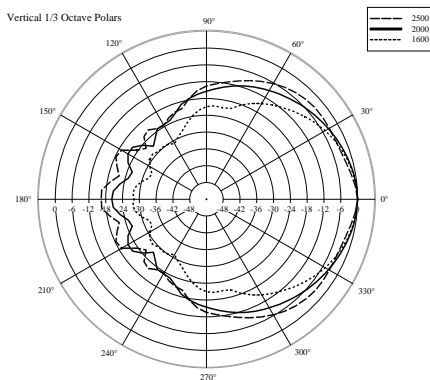
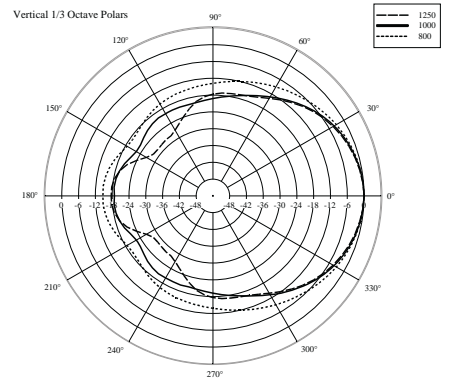
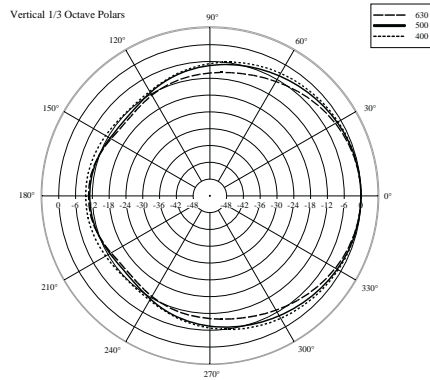
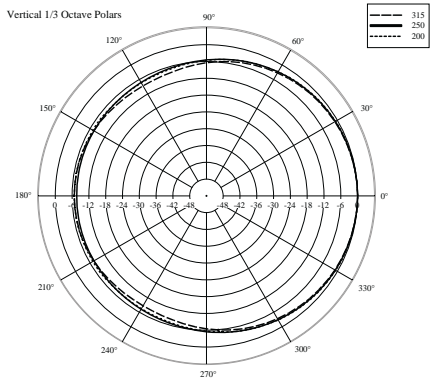
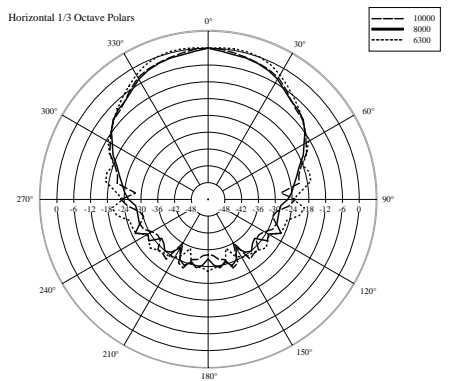
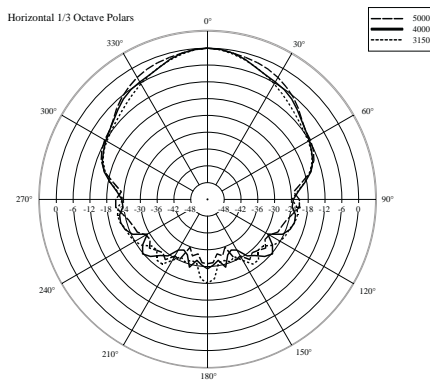
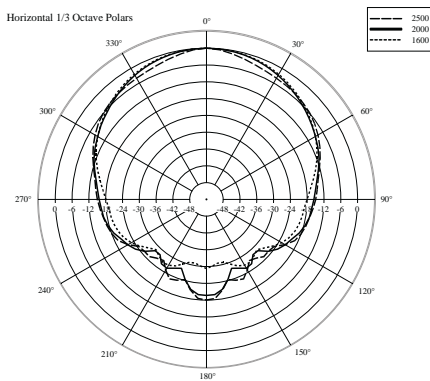
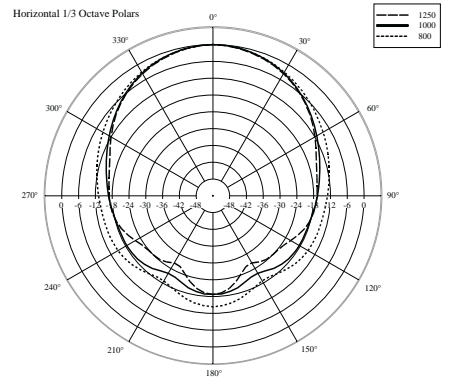
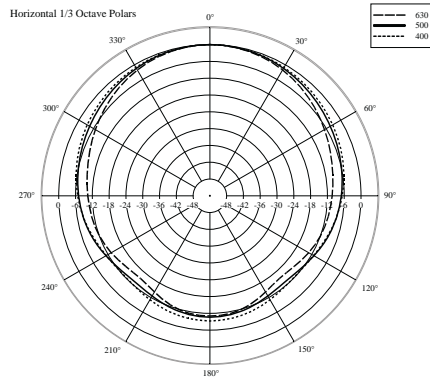
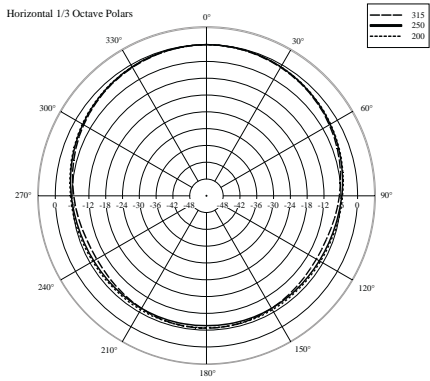

ACCESSORIES



AC P10 A-BR CLUSTER BRACKETS FOR P2110

PART NUMBER

13360095

EAN:

8024530006112
