

TT 052-A

ULTRA COMPACT HIGH OUTPUT SPEAKER

DESCRIPTION

The TT052-A is an extremely compact, active loudspeaker specifically designed for indoor applications where the audio beam must be directed towards specific zones.

It is equipped with two 5" neodymium woofers and a 1" compression driver. Thanks to its constant directivity horn and high volume output, the TT052-A can be used to guarantee the perfect intelligibility in critical environments.



FEATURES

- 300 W Class D amplifier
- Heavy duty multi-functional cabinet
- 2 x 5" low distortion woofer
- 1" ne compression driver, 1.5" v.c.
- DSP processing
- Wall mount EQ, High pass EQ
- RDNet ready

TECHNICAL SPECIFICATIONS

| | | |
|----------------------------------|----------------------------|------------------------|
| Acoustical specifications | Frequency Response: | 65 Hz ÷ 20000 Hz |
| | Max SPL @ 1m: | 123 dB |
| | Horizontal coverage angle: | 90° |
| | Vertical coverage angle: | 90° |
| Transducers | Compression Driver: | 1 x 1.0" neo, 1.5" v.c |
| | Woofers: | 2 x 5.0", 1.0" v.c |
| Input/Output section | Input signal: | bal/unbal |
| | Input connectors: | XLR |
| | Output connectors: | XLR |
| | Input sensitivity: | -2 dBu/+10 dBu |
| Processor section | Crossover Frequencies: | 1500 Hz |
| | Protections: | Thermal, Excurs., HF |
| | Limiter: | Soft Limiter |
| | Controls: | DSP Controlled |
| | RNet: | Ready |
| Power section | Total Power: | 600 W Peak, 300 W RMS |
| | High frequencies: | 300 W Peak, 150 W RMS |
| | Low frequencies: | 300 W Peak, 150 W RMS |
| | Cooling: | Convection |
| | Connections: | Powercon IN/OUT |
| Standard compliance | CE marking: | Yes |
| Physical specifications | Cabinet/Case Material: | Baltic birch plywood |
| | Hardware: | Multi-functional |
| | Handles: | Top, Bottom |
| | Grille: | Steel |
| | Color: | Black |
| Size | Height: | 493 mm / 19.41 inches |
| | Width: | 150 mm / 5.91 inches |
| | Depth: | 190 mm / 7.48 inches |
| | Weight: | 9.5 kg / 20.94 lbs |
| Shipping informations | Package Height: | 580 mm / 22.83 inches |
| | Package Width: | 290 mm / 11.42 inches |
| | Package Depth: | 220 mm / 8.66 inches |
| | Package Weight: | 11 kg / 24.25 lbs |



PART NUMBER

• **13000246**

TT 052-A

115V

EAN 8024530008949

• **13000245**

TT 052-A

220-240V

EAN 8024530008932

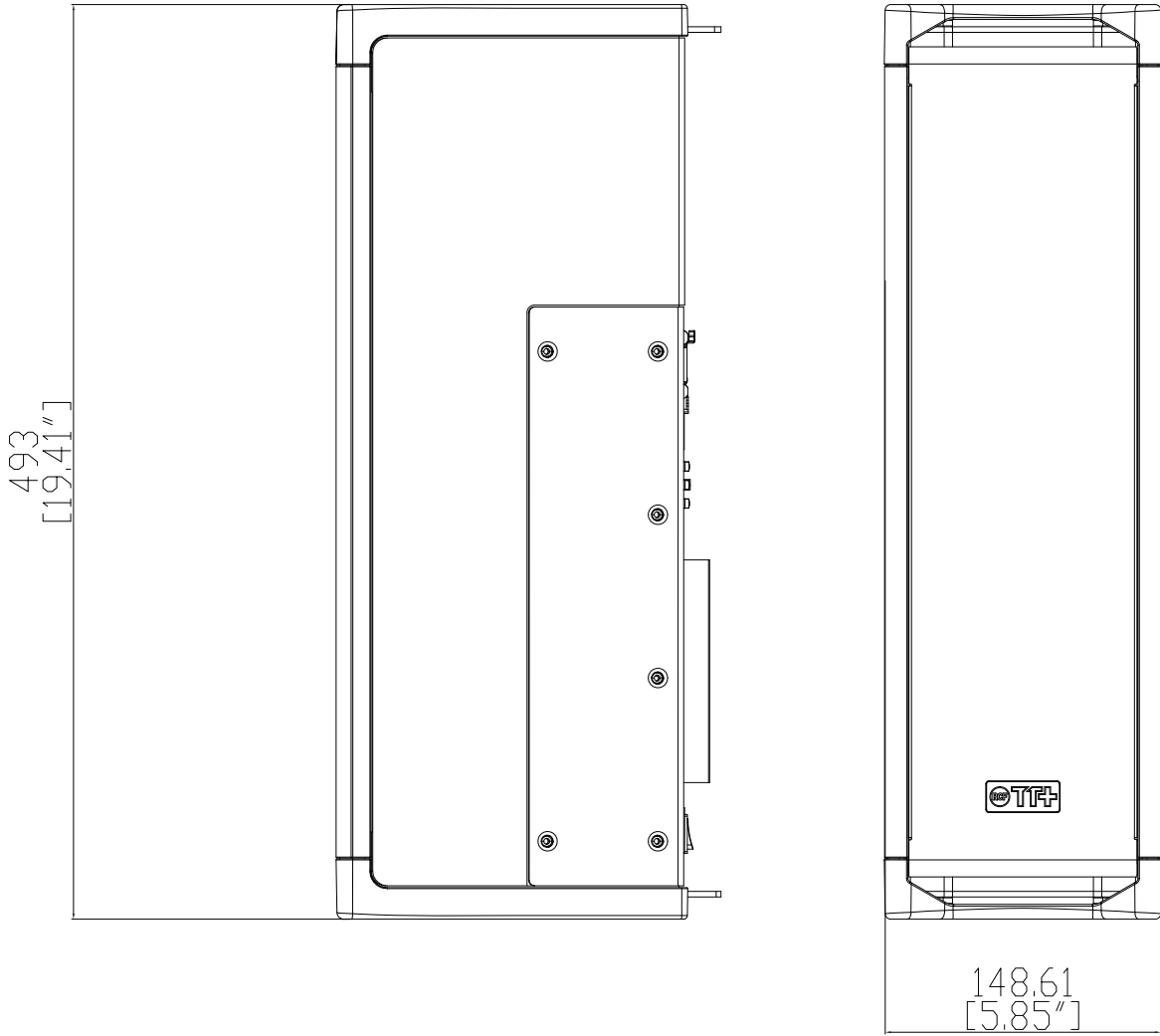

TT052-A

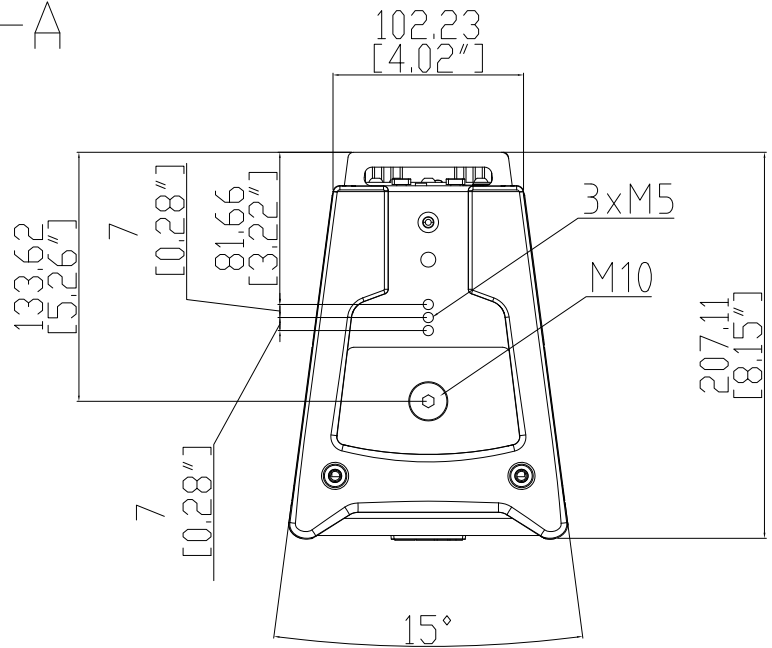

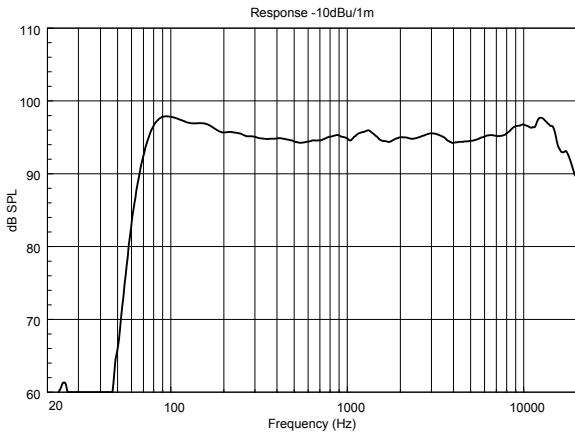

TT052-A

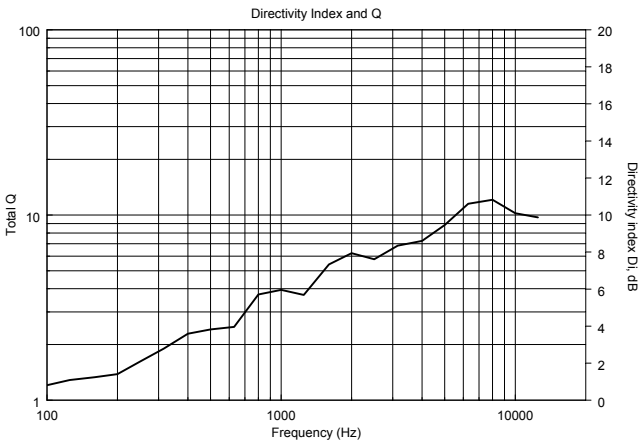
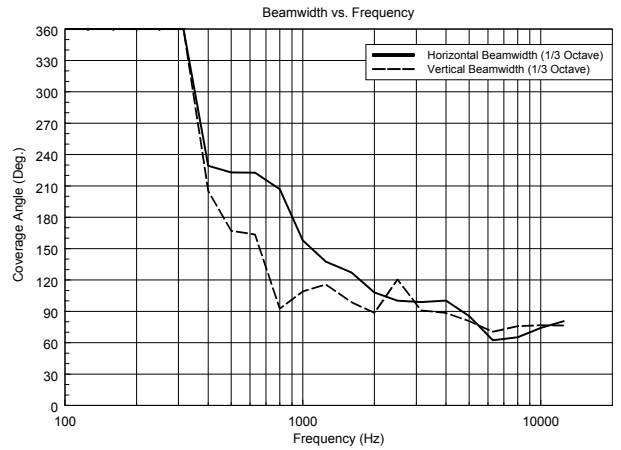

TT052-A

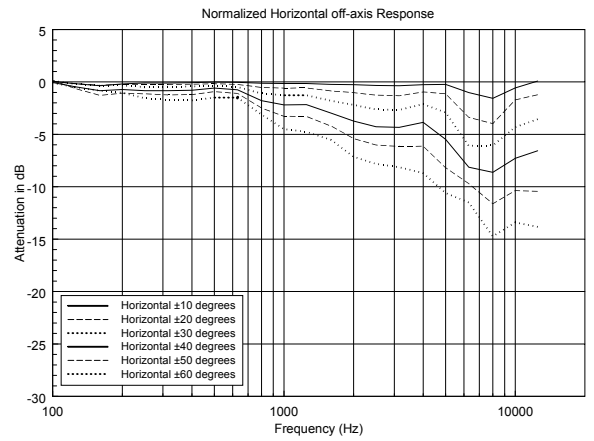

TT052-A

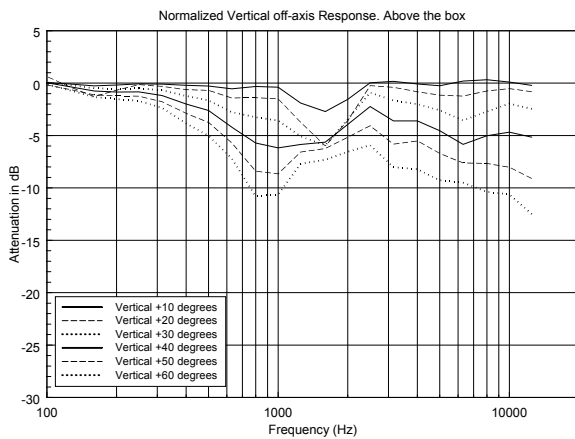

TT052-A

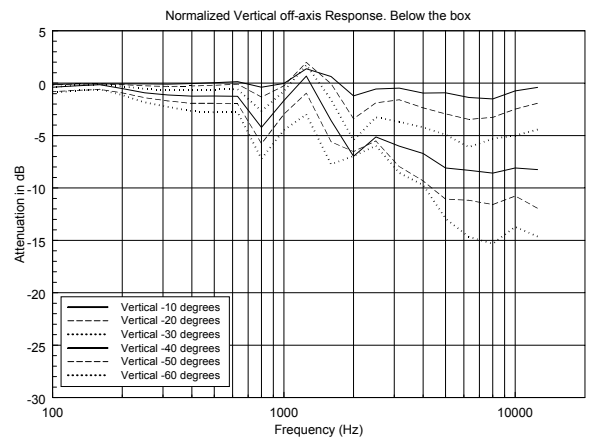

TT052-A

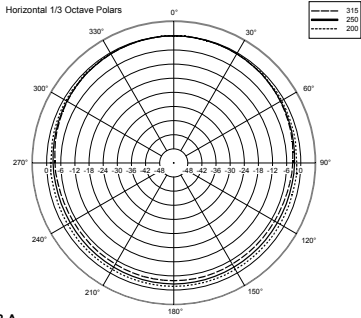

TT052-A

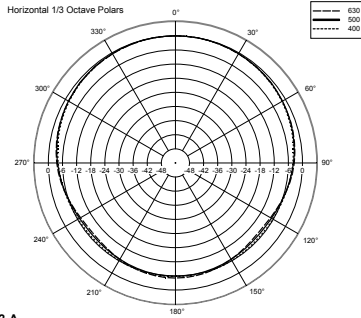

TT052-A

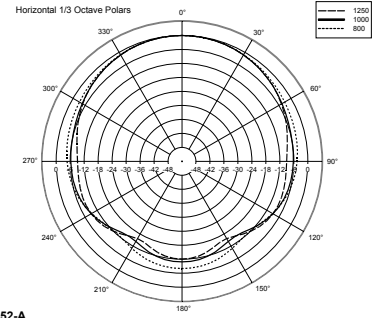

TT052-A

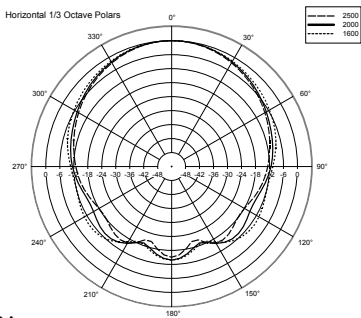

TT052-A

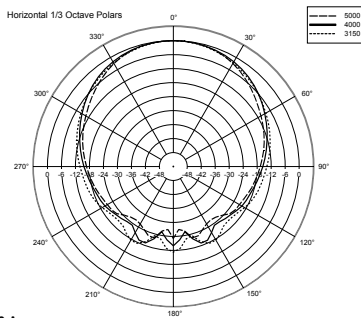

TT052-A

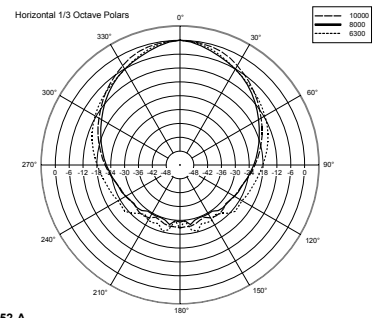

TT052-A

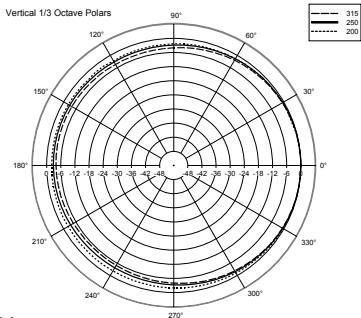

TT052-A

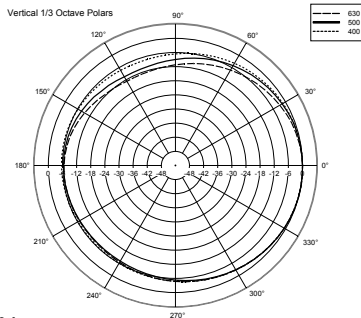

TT052-A

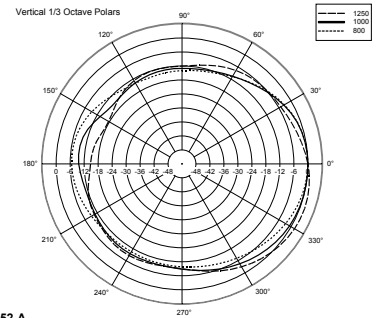

TT052-A

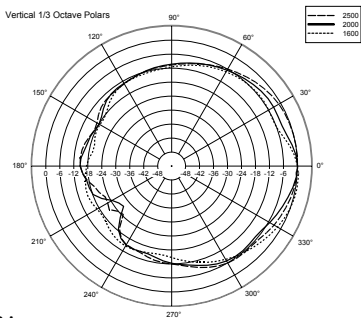

TT052-A

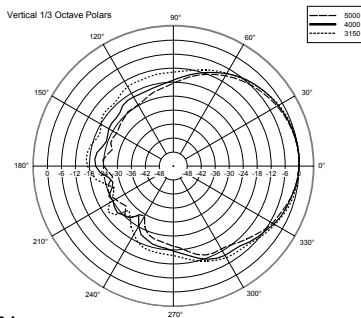

TT052-A

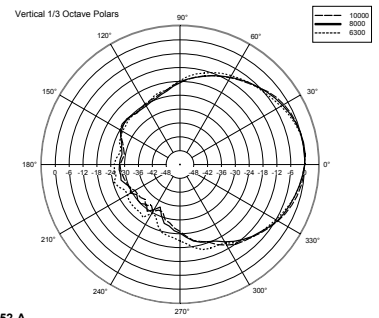

TT052-A