

HD 21EN

PLASTIC HORN SPEAKER

DESCRIPTION

HD 21EN is a plastic horn speaker suitable for broadcasting alarm messages thanks to the highly intelligible sound reproduction and its environmental resistance. The terminal connection blocks, for input and output flameproof cables, are made of ceramic material. A thermal fuse protects the integrity of the line in case of heat affecting the speaker. It can be easily aimed towards any direction through the adjustable wall-mount bracket, and thanks to its IP66 protection grade it can be installed both indoor and outdoor.



FEATURES

- 1.5" compression driver.
- Power selectable (100 V): 30 W – 15 W – 7.5 W – 3.75 W.
- 104 dB sensitivity.
- Colour grey RAL 7035.
- Plastic body.
- In/out ceramic terminal block.
- Thermal fuse protection.
- Protection grade IP66.

TECHNICAL SPECIFICATIONS

Acoustical specifications	Frequency Response (-10dB):	340 Hz ÷ 9000 Hz
	Max SPL @ 1m:	117 dB
	Max SPL @ 4m:	105 dB
	Coverage angle:	135°
	System Sensitivity:	104 dB
	System Sensitivity 1W @ 4m:	92 dB
Power section	Power Handling:	30 W
	Peak Power Handling:	120 W PEAK
	Recommended Amplifier:	60 W
	Protections:	Thermal fuse
Transducers	Compression Driver:	1 x 1.5"
Input/Output section	Input connectors:	Ceramic screw terminals
	Output connectors:	Ceramic screw terminals
	Constant Voltage Transformer:	100 V
	Power selection 1:	30 W - 333 ohm
	Power selection 2:	15 W - 667 ohm
	Power selection 3:	7.5 W - 1333 ohm
Power selection 4:	3.75 W - 2667 ohm	
Standard compliance	IP protection grade:	IP 66
	EN54-24 certified:	Yes
	CE compliance:	Yes
	CPR number:	1488-CPR-0652/W
Physical specifications	Cabinet/Case Material:	ABS
	Hardware:	Stainless steel bracket
	Color:	Grey - RAL 7035
Size	Height:	212 mm / 8.35 inches
	Depth:	280 mm / 11.02 inches
	Weight:	2.1 kg / 4.63 lbs
Shipping informations	Package Height:	220 mm / 8.66 inches
	Package Width:	320 mm / 12.6 inches
	Package Depth:	220 mm / 8.66 inches
	Package Weight:	2.7 kg / 5.95 lbs



PART NUMBER

- **13133075**

HD 21EN

EAN 8024530010461

DRAWINGS

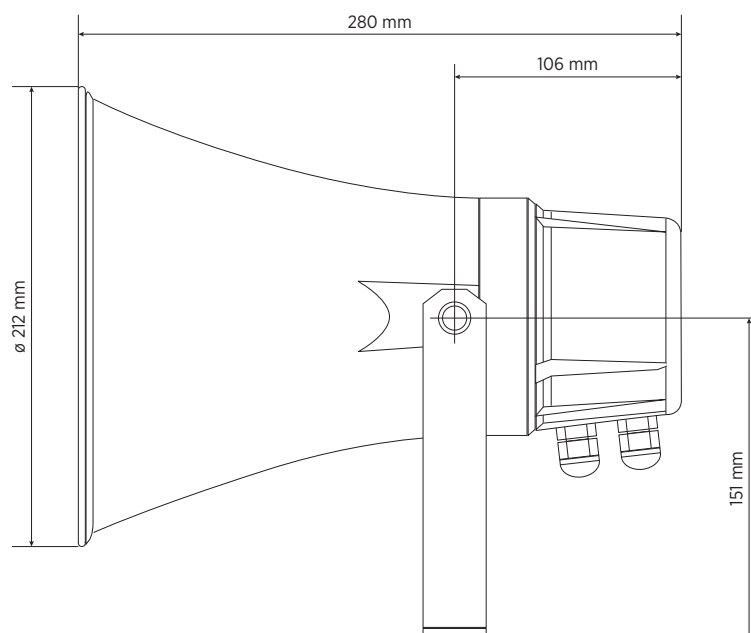
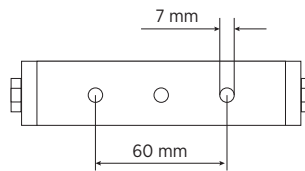
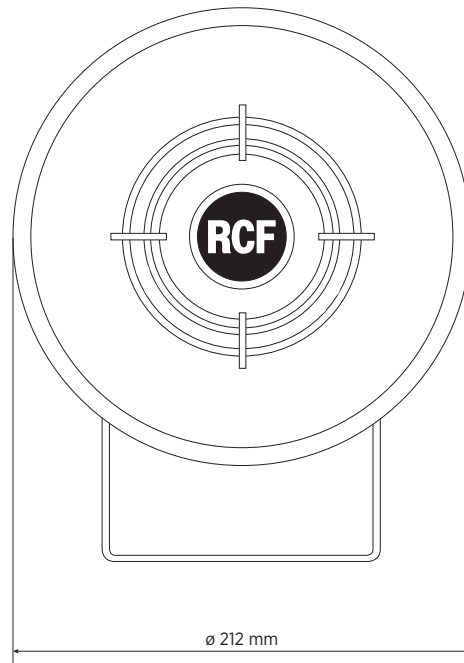

SCHEMATICS

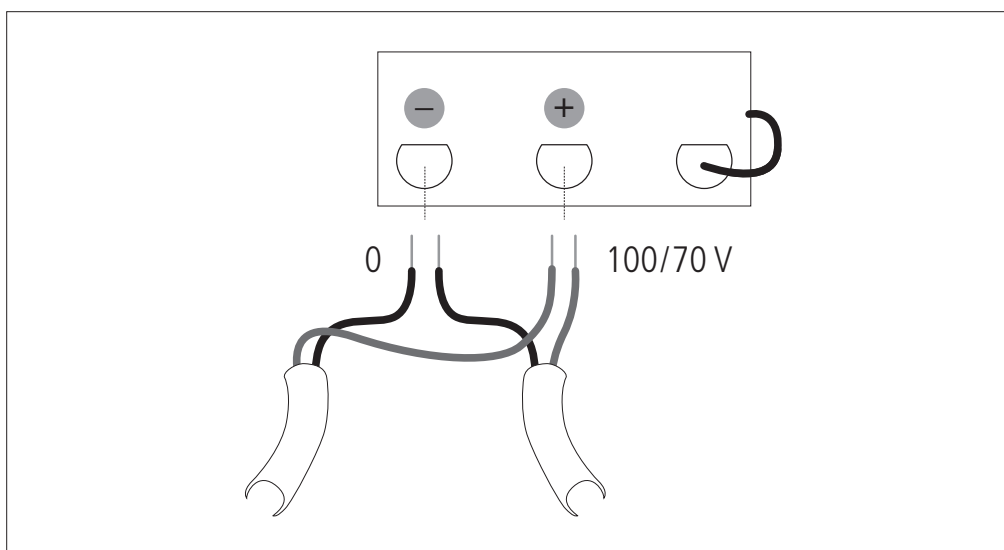

TAPS	POWER (100 V)	POWER(70 V)
1	3.75 W	1.875 W
2	7.5 W	3.75 W
3	15 W	7.5 W
4	30 W	15 W

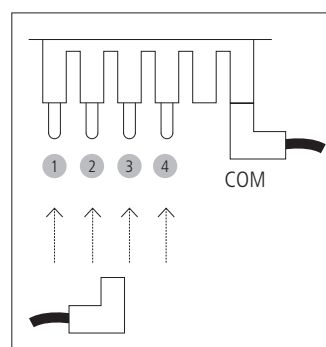

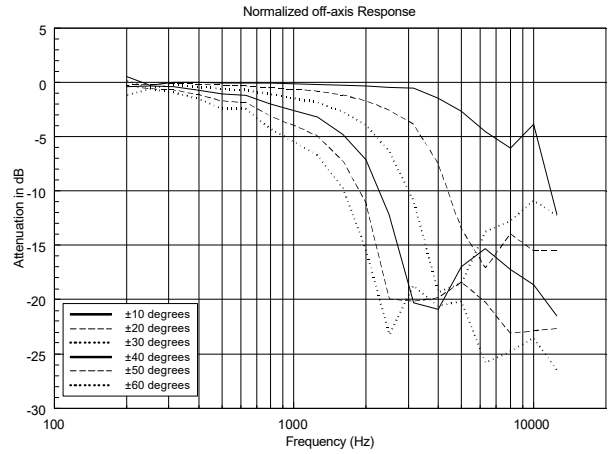
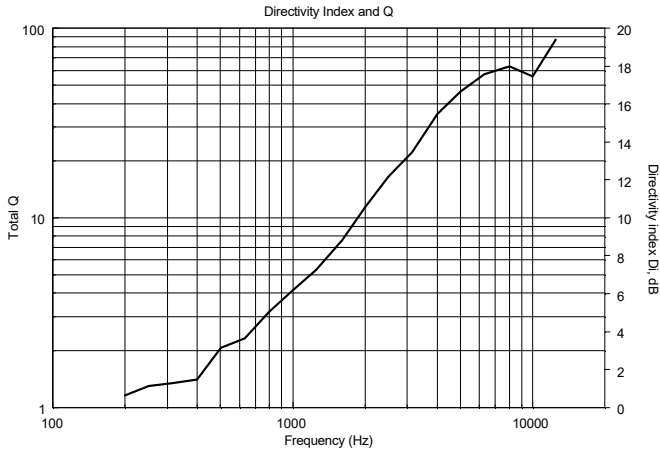
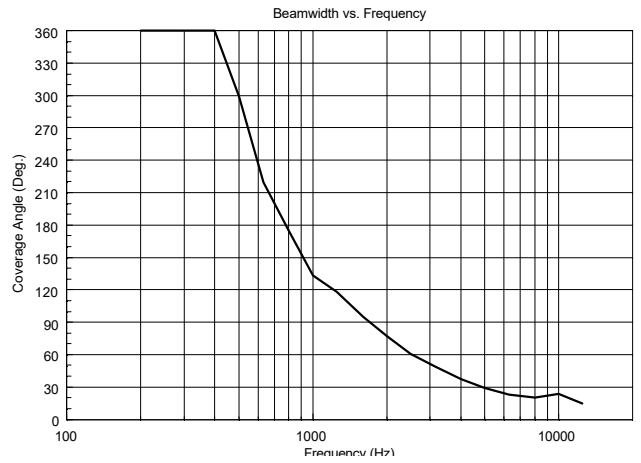
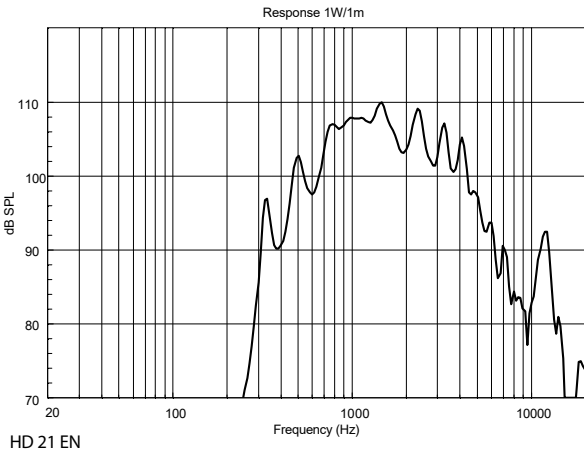

HORIZONTAL 1/3 POLAR PLOT

1/3 Octave Polars

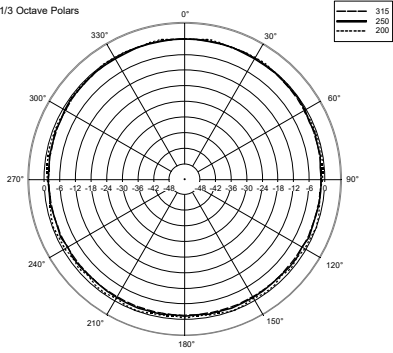

1/3 Octave Polars

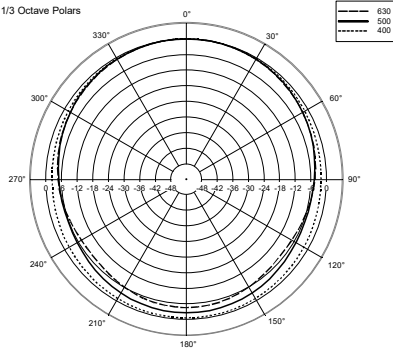

1/3 Octave Polars

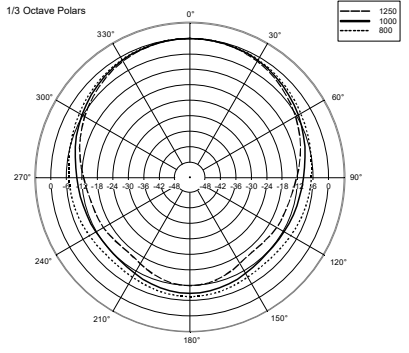

1/3 Octave Polars

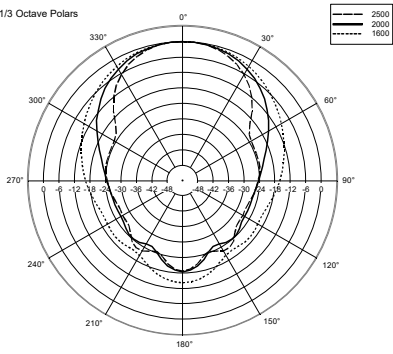

1/3 Octave Polars

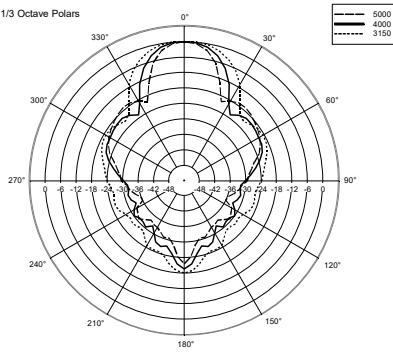

1/3 Octave Polars

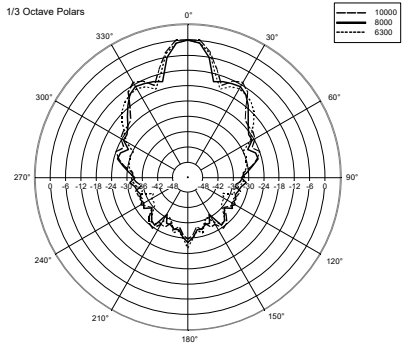

ACCESSORIES



CV 225 CABLE SPEAKER 100V SEZ 2X2.5MMQ EV

PART NUMBER

14380032

EAN:

8024530012182

A&E SPECIFICATIONS

The product shall be a plastic horn speaker for alarm messages (and background music as well), thanks to the highly intelligible voice reproduction and the EN 54-24 certification.

It shall have IP66 protection grade for both indoor and outdoor installations.

It shall feature a ABS body and a stainless steel bracket support.

The terminal connection blocks, for input and output flameproof cables, shall be made of ceramic material. A thermal fuse shall protect the line integrity in case of heat affecting the speaker.

NOTES

NO CAUTION is NECESSARY in case of ALERTED PERSON for AUDIO voltages up to 120V, when warning symbols are present near the connection terminals. In the case of AUDIO voltages up to 71V, it is not even necessary to put warning symbols.

No need of linking to earth metal parts of speakers equipped with transformers and connected to 70.7 V / 100 V outputs of power amplifiers that do not have any reference to earth (ref. EN 62368-1 item 4.3.2.2), unless specific local requirements.
